

Coupling Alignment

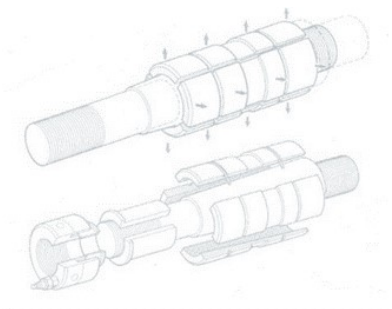

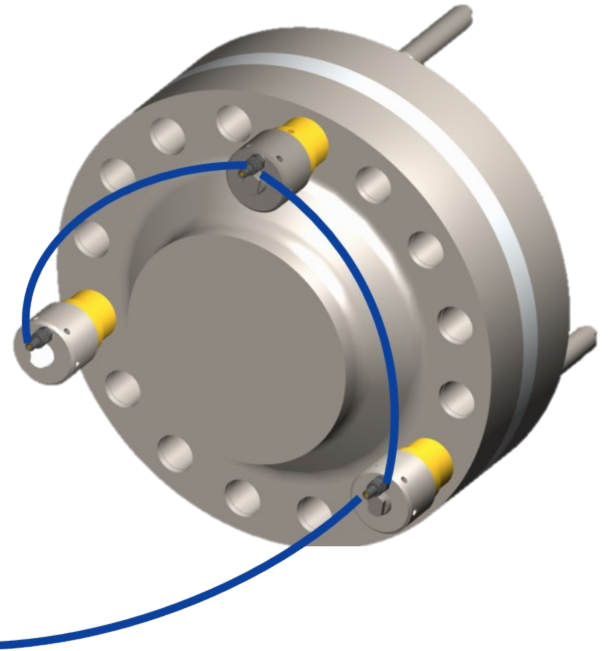

Based upon similar working principles of Pilgrim's Radially Fitted Bolt, the **CHAT tool** is hydraulically expanded up to +1.5mm of nominal hole size, forcing quick and safe re-alignment.

Depending upon the coupling size, each CHAT package consists of between 3 and 4 tool assemblies. The tools are inserted into equi-spaced flange holes and are simultaneously pressurised to align the coupling holes. The coupling faces are then closed using the tools in preparation for installation of the coupling bolts.



Unique expanding sleeve design

Benefits

-  Aides quick coupling alignment and closure
-  Safe and friendly to operate
-  Increased profit by reducing unplanned costs and allowing for accurate planning
-  Accurate and reliable
-  Removes possibility of galling damage to bolts and coupling face / bore



+44 (0) 161 785 7700



sales@pilgrim-international.co.uk



www.pilgrim-international.co.uk

To explore more, please contact your local sales contact or scan the QR code and visit us at:

CHAT_Flyer_PIL_PRO_008-EN2

